

FOUR TIER PLASTIC LOCKER ASSEMBLY INSTRUCTIONS

Thank you for choosing H94000 Series Four Tier Plastic Lockers from National Mailboxes. These instructions are intended to assist you in a typical locker Assembly. Individual job conditions will dictate the type of fasteners and whether the lockers must be anchored to the wall, floor, or both. Assembly instructions are provided as general guidelines. It is advised that a professional installer be consulted. National Mailboxes assumes no product assembly or installation liability. Please read entire assembly instructions before beginning assembly.

Step 1. Insert the back panel tabs into the pockets along the rear edge of the side panel. Tap with soft mallet to engage two (2) latch points.



Step 2. Press another side panel onto the tabs on the other side of the back panel. Tap to engage as above.

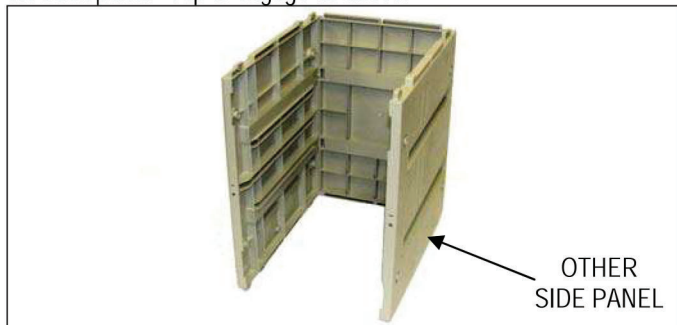

Step 3. Join and press down the sides-and-back-panel assembly from step 2 above into the base panel as shown below. The base panel is the thicker of the five (5) horizontal panels provided. Then thread four (4) leveling feet provided into the bottom of the base panel.

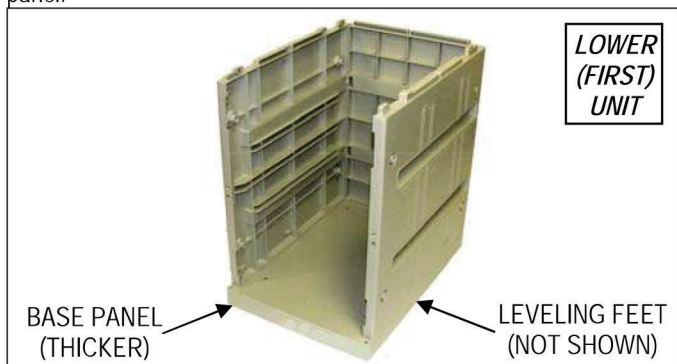

Step 4. Install a thinner top horizontal panel on top of the unit.

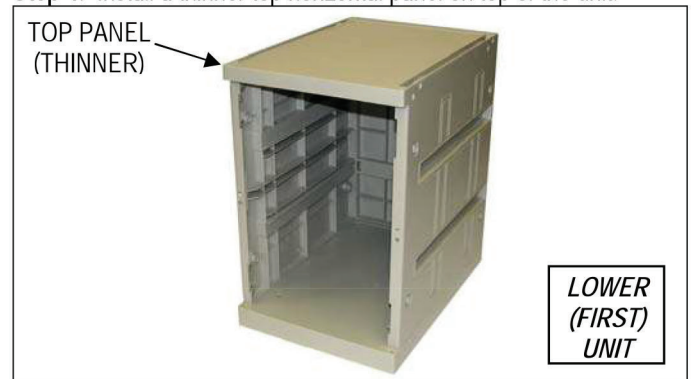

Step 5. Assemble three (3) identical units the same as Steps 1 through 4, except installing the thinner top panel on each instead of the thicker base panel. These units will not have leveling feet.

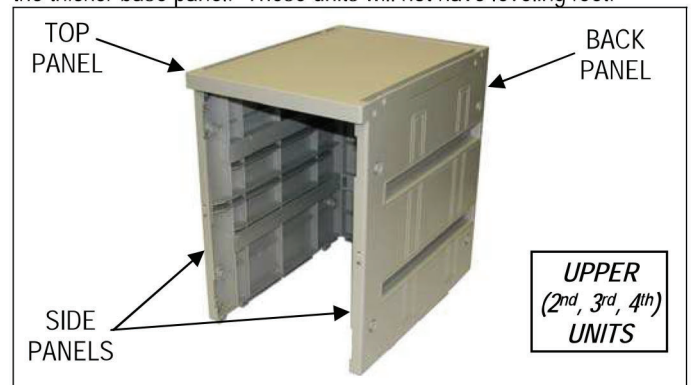

Step 6. If no optional sloping hood is ordered, install the three (3) filler strips into the recesses in the top panel of one (1) of the upper units. This will be the uppermost unit after the units are stacked.



NATIONAL MAILBOXES
A DIVISION OF NMHP INC.

North America's Commercial & Residential Mailbox Leader!

Installation instructions are provided as general guidelines. It is advised that a professional installer be consulted. National Mailboxes assumes no product assembly or installation liability.

FOUR TIER PLASTIC LOCKER ASSEMBLY INSTRUCTIONS

Step 7. Stack the three (3) upper units onto the lower unit. Press all units firmly together. Use a mallet if necessary.

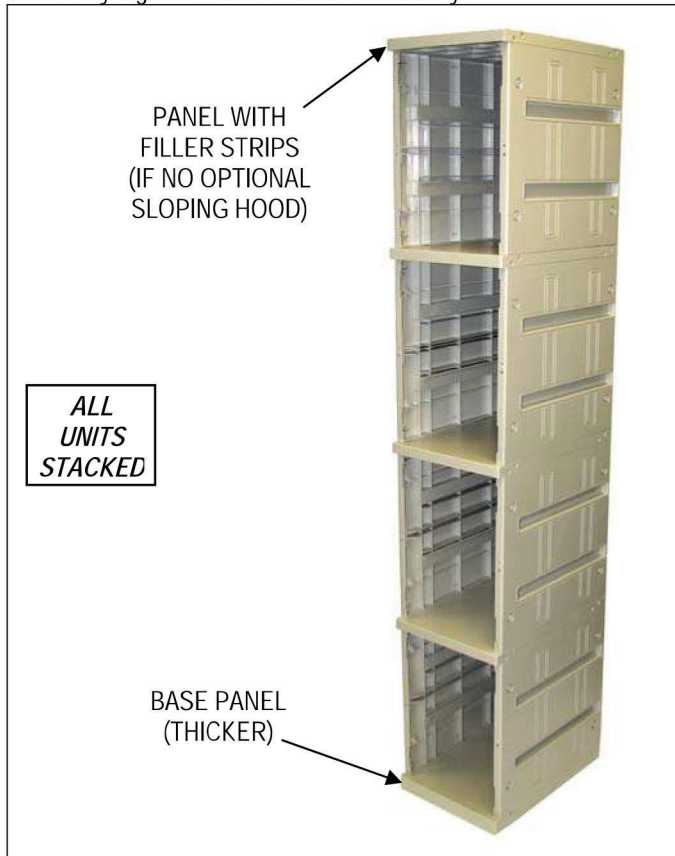

Step 9. Attach the plastic oval lock plate to the front of the four (4) doors with two (2) screws from the rear of the door. Insert the stainless steel hasp through hole in front of doors making sure cutout is facing downward. Secure by threading nut provided onto it from rear. Insert lock knob through hasp from front of door making sure hole in lock knob is facing downward. Attach cam to rear of lock knob shaft with screw provided. Be sure the cam is pointing toward the outside of the door and is properly engaged with the square shaft end of the lock knob.

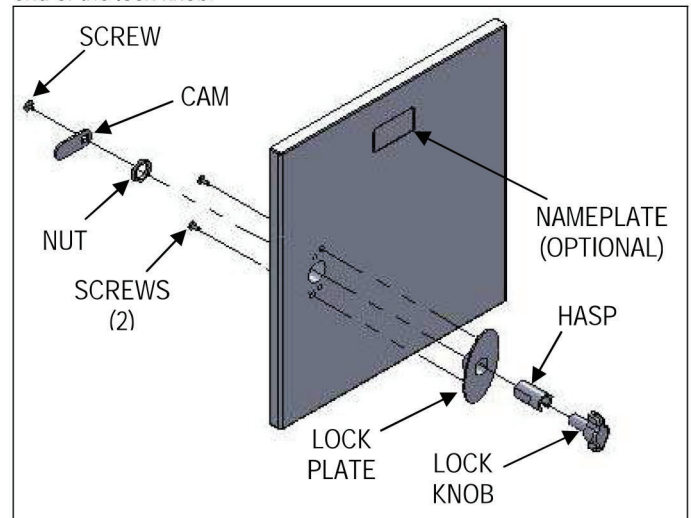

Step 10. Fasten the eight (8) hinges (two (2) for each of the four (4) doors) provided in the hardware package securely to each hinge position with the screws provided as shown below. Fasten each of the four (4) doors to the appropriate pair of hinges.

Step 8. Install screws and hole covers where side panels join to top panels and base panel. There are 18 screws and hole covers on each of the two sides of the assembly (36 in total).

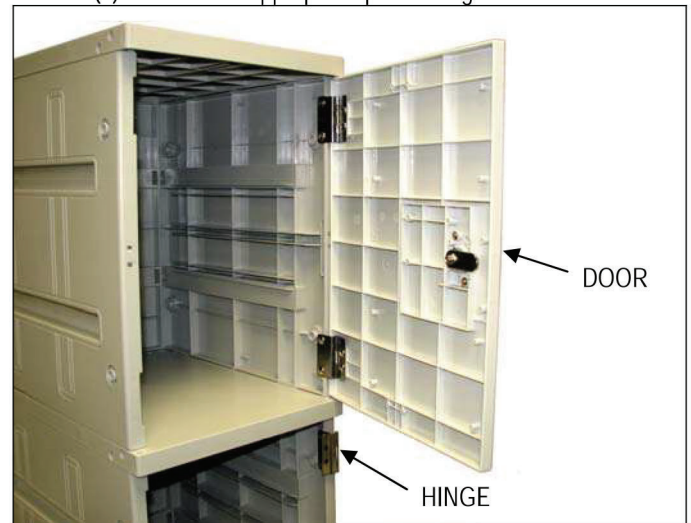
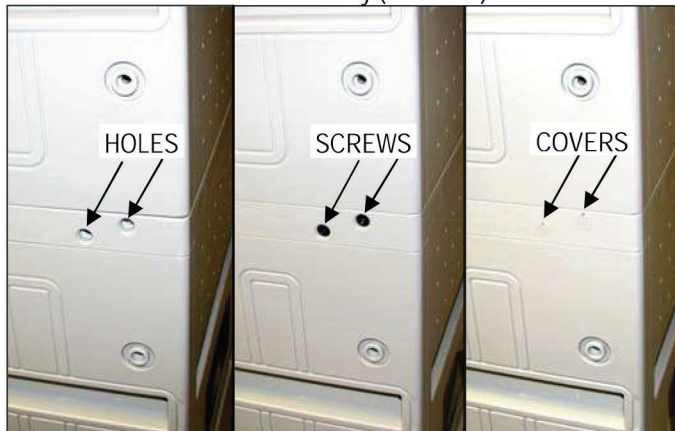

NATIONAL MAILBOXES

A DIVISION OF NMHP INC.

North America's Commercial & Residential Mailbox Leader!

Installation instructions are provided as general guidelines. It is advised that a professional installer be consulted. National Mailboxes assumes no product assembly or installation liability.

FOUR TIER PLASTIC LOCKER ASSEMBLY INSTRUCTIONS

Step 11. Slide the shelves (optional) into the slots in the locker side panels. There are three (3) slots available for shelves in each of the four (4) compartments.



Step 12. Install the sloping hood (optional) to the top of each locker column by aligning six (6) locating tabs with the topmost panel. Press locating tabs into place. Illustration shows sloping hood before pressing tabs into place. Plastic filler strips shown in step 6 are not required on units with a sloping hood and can be discarded.

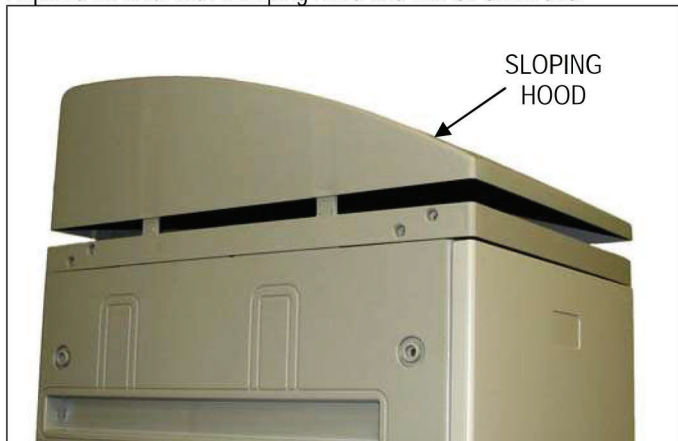

Step 13. Install placards (optional) in the indentation near the top of each door.

Step 14. If two (2) or more lockers are to be installed side by side, the lockers should be fastened together with the four (4) nuts and long screws provided. Select any two (2) holes toward the front and any two (2) holes toward the rear. The illustration below shows the 16 holes that are available. The lower illustration shows the inside view of a hole and screw.

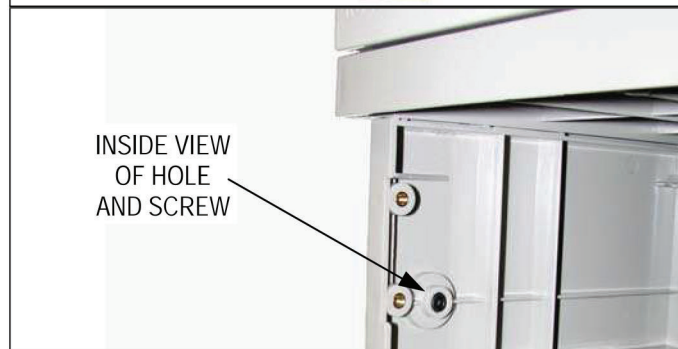

The assembly of the plastic lockers is now complete.



NATIONAL MAILBOXES

A DIVISION OF NMHP INC.

North America's Commercial & Residential Mailbox Leader!

Installation instructions are provided as general guidelines. It is advised that a professional installer be consulted. National Mailboxes assumes no product assembly or installation liability.